

**PEOPLE
PRODUCTS
PROGRAMS**

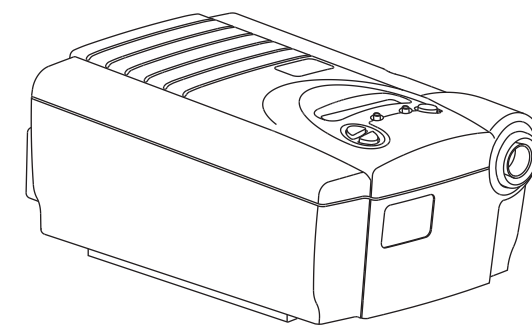

REMstar® | pro
CPAP System

User Manual



RESPIRONICS INC.®
1001 Murry Ridge Lane
Murrysville, Pennsylvania
15668-8550 USA

RESPIRONICS®
Deutschland
Gewerbstrasse 17
82211 Herrsching Germany



1007167
LK 5/12/01



Table of Contents

Symbol Key	2
Intended Use	3
Specifications	4
Warnings & Cautions	5
Unpacking the System	6
System Features	7
First Time Setup	8
Installing the Filter	9
Device Settings	11
Assembling the Circuit	15
Accessories	16
Adding a Humidifier	16
Adding Oxygen	16
Using DC Power	17
Using an Ultra-fine Filter	17
Carrying Case	17
Routine Use	18
Connecting the Circuit	18
Adjusting the Circuit	18
Starting Ramp	19
Turning the System Off	19
Helpful Hints	19
Screen Messages	20
Traveling with the System	22
Routine Maintenance	23
Filter	23
Cleaning	24
Reordering	24
Service	24
Troubleshooting	26
Warranty	28

Symbols



Pressure ON / OFF



Ramp



Heated Humidifier ON / OFF



DC Power



Type BF Applied Part



Class II (Double Insulated)

IPX0

Ordinary Equipment



**Attention, consult
accompanying documents**



European CE Marking

This CPAP System is the subject of U.S. patent #5239995 and other pending U.S. and foreign patents.

REMstar is a trademark
of Respironics, Inc.

© Respironics, Inc. 2001

Intended Use

The Respironics Pro System is a continuous positive airway pressure (CPAP) device designed for the treatment of adult Obstructive Sleep Apnea (OSA) only.

The REMstar Pro is to be used only on the instruction of a licensed physician. Your home care provider will make the correct pressure settings according to your physician's prescription.

Several accessories are available to make your OSA treatment with the REMstar Pro system as convenient and comfortable as possible. To ensure that you receive the safe, effective therapy prescribed for you, use only Respironics accessories.

IMPORTANT!

Read and understand the entire user's manual before operating this system. If you have any questions concerning the use of this system, contact your home care provider or doctor.

Contraindications

Studies have shown that the following preexisting conditions may contraindicate the use of positive airway pressure therapy for some patients:

- Bullous Lung Disease
- Pathologically Low Blood Pressure
- Pneumothorax
- Pneumocephalus has been reported in a patient using nasal Continuous Positive Airway Pressure. Caution should be used when prescribing CPAP for susceptible patients such as those with: cerebral spinal fluid (CSF) leaks, abnormalities of the cribriform plate, prior history of head trauma, and/or pneumocephalus. (Chest 1989; 96:1425-1426)

The use of positive airway pressure therapy may be temporarily contraindicated if you exhibit signs of a sinus or middle ear infection. Not for use with patients whose upper airways are bypassed. Contact your physician if you have any questions concerning your therapy.

Specifications

Device Size	Dimensions: 9 1/2" x 6 7/8" x 4 3/4" (24 x 17 x 12 cm) Weight: 4 lbs. (1.8 kg)												
Product Use, Transport, and Storage	<table><thead><tr><th></th><th>Operation</th><th>Transport & Storage</th></tr></thead><tbody><tr><td>Temperature:</td><td>41 to 95° F (5 to 35° C)</td><td>-4 to 140° F (-20 to 60° C)</td></tr><tr><td>Humidity:</td><td>15 to 95% Non-condensing</td><td>15 to 95% Non-condensing</td></tr><tr><td>Atmospheric Pressure:</td><td>82.8 to 102 kPascals</td><td>50 to 102 kPascals</td></tr></tbody></table>		Operation	Transport & Storage	Temperature:	41 to 95° F (5 to 35° C)	-4 to 140° F (-20 to 60° C)	Humidity:	15 to 95% Non-condensing	15 to 95% Non-condensing	Atmospheric Pressure:	82.8 to 102 kPascals	50 to 102 kPascals
	Operation	Transport & Storage											
Temperature:	41 to 95° F (5 to 35° C)	-4 to 140° F (-20 to 60° C)											
Humidity:	15 to 95% Non-condensing	15 to 95% Non-condensing											
Atmospheric Pressure:	82.8 to 102 kPascals	50 to 102 kPascals											
Standards Compliance	This device is designed to conform to the following standards: IEC 60601-1 Medical Electrical Equipment - General Requirements for Safety IEC 60601-1-2 Electromagnetic Compatibility US Deviations (UL 2601-1:1997) Canada Deviations (CAN/CSAC22.2 No. 601.1-M90)												
Mode of Operation	Continuous												
Power Requirements	AC Power Consumption: 100 to 240 VAC, 50/60 Hz, 1.0 A max. DC Power Consumption: 12 VDC, 3.0 A max.												
Type of Protection Against Electric Shock	Class II Equipment												
Degree of Protection Against Electric Shock	Type BF Applied Part												
Degree of Protection Against Ingress of Water	IPX0 - Ordinary Equipment												
Pressure Range	4 to 20 cm H ₂ O (in 1 cm increments)												

Warnings & Cautions

CAUTION!

- *US federal law restricts this device to sale by or on the order of a physician.*

WARNING!

Indicates the possibility for injury to the user or the operator.

- *The instructions in this manual are not intended to supersede established medical protocols.*
- *This device is intended for adult use only.*
- *This device is not intended for life support.*
- *CPAP devices have the potential to allow rebreathing of exhaled air. To reduce this potential, observe the following:*
 - *Use only Respironics circuit accessories.*
 - *Do not wear the mask and headgear for more than a few minutes while the device is not operating.*
 - *Do not block or try to seal the vent holes in the exhalation port*

As with most CPAP devices: At low CPAP pressures, some exhaled gas (CO₂) may remain in the mask and be rebreathed.

- *Do not use this device if the room temperature is warmer than 95° F (35° C). If this device is used at room temperatures warmer than 95° F (35° C), the temperature of the airflow may exceed 106° F (41° C). This could cause irritation to your airway.*
- *This equipment is not suitable for use in the presence of a flammable anaesthetic mixture in combination with oxygen or air, or in the presence of nitrous oxide.*
- *To avoid electrical shock, disconnect the power cord before cleaning. DO NOT immerse the device in any fluids*
- *Contact your doctor if symptoms of sleep apnea recur.*

CAUTION!

Indicates the possibility of damage to the device.

- *If you notice any unexplained changes in the performance of this device, if it is making unusual or harsh sounds, if it has been dropped or mishandled, if the enclosure is broken, or if water has entered the unit, discontinue use and contact your home care provider.*
- *Tobacco smoke may cause tar build-up within the REMstar Pro that may result in the REMstar Pro malfunctioning.*

Additional warnings and cautions are located throughout this manual as they apply.

Unpacking the System

After unpacking the system, check to make sure you have everything shown here:

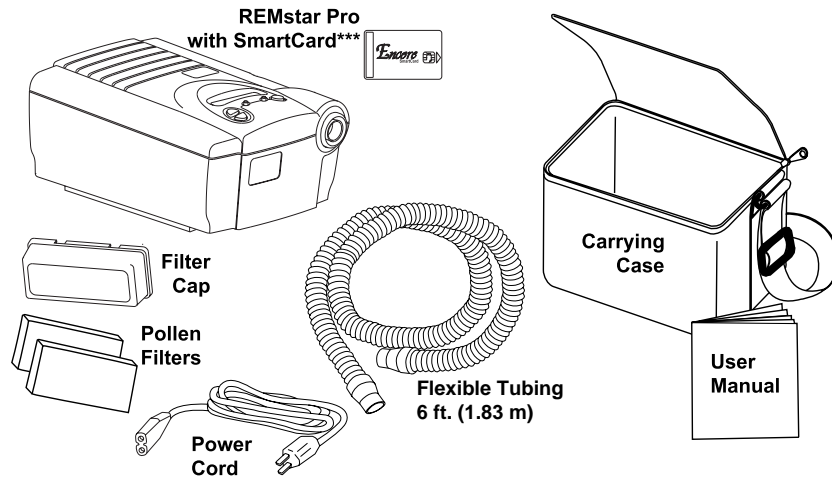

IMPORTANT! *If any of the above parts are missing, contact your home care provider.*

***The Encore SmartCard is a new feature which records the CPAP usage. Another new feature is the FOSQ “Quality of Life” questionnaire. Your doctor or home care provider may ask you to periodically complete this questionnaire and send your answers (recorded on the SmartCard). The FOSQ questionnaire is detailed in the enclosed “Sleep Solutions” brochure.

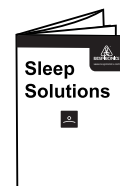

System Features

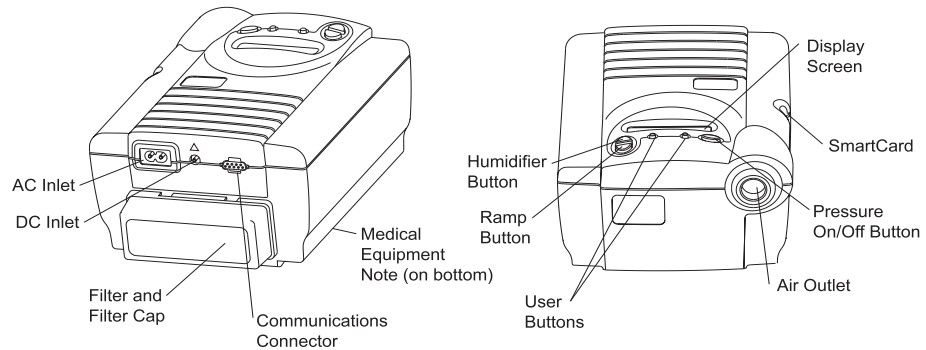

AC Inlet Connect the power cord here.

Air Outlet Connect the flexible tubing here.

Communications Connector .. For clinical use with the Encore® Data Management Software or an IEC 950 approved device. Connect the communications cable here.

DC Inlet Connect the optional DC power cord here.

Display Screen All System settings, total operating time, and therapy hours will be displayed here.

Filter Cap & Filter The pollen filter screens out normal household dust and pollens. The filter cap is designed to quiet the CPAP device.

Humidifier Button This button turns the REMstar Heated Humidifier on / off and allows the heater setting to be adjusted. This is an optional accessory that may be purchased separately

Medical Product Note For convenience at airport security stations, a note on the bottom of the device states that it is medical equipment. Taking this manual with you when you travel also may help you at security checkpoints.

Pressure On / Off

Button This button turns the airflow on or off.

Ramp Button This button starts the ramp cycle or accesses the device settings.

SmartCard The SmartCard records device usage information (e.g., times the system was used for therapy). Contact your home care provider for further information about the SmartCard.

User Buttons These buttons can be used to change some of the system settings and to answer the FOSQ quality of life questionnaire.

First Time Setup

WARNING!

DO NOT use the REMstar Pro system until an appropriate professional adjusts the settings!

Note to home care provider: Before beginning setup, be sure that you have available the REMstar Pro Home Care Provider Setup Instructions. It contains instructions for setting up the REMstar Pro.

WARNING!

DO NOT connect any equipment to the REMstar Pro unless recommended by Respironics or your doctor.

WARNING!

Respironics circuit accessories (i.e., nasal mask, exhalation port, tubing) are for single patient use only and are not intended to be used on multiple patients.

CAUTION!

If the REMstar Pro has been exposed to either very hot or very cold temperatures, allow it to adjust to room temperature (approximately 2 hours) before beginning setup.

ATTENTION!

The SmartCard does not need to be installed for the REMstar Pro to work properly. The SmartCard records device usage information for use by your home care provider. Contact your home care provider if you have any questions about the SmartCard.

Installing Filters

CAUTION!

1. Install the filter and filter cap. For additional filter options, refer to the Accessories section on page 17.

The pollen filter must be in place at all times when the device is operating.

a. Place one of the filters into the filter area on the back of the REMstar Pro. An extra filter is included for your convenience.

b. Attach the filter cap. Position the cap so that the small opening on the cap is facing down. Insert the cap's bottom tabs into the openings below the filter area. Press down on the cap's top tabs and insert them into the openings above the filter area.

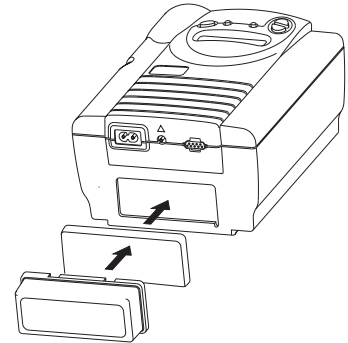

Power Cord

CAUTION!

2. Connect the power cord.

Plug the socket end of the power cord into the AC inlet on the back of the REMstar Pro. Plug the pronged end of the power cord into an electrical outlet.

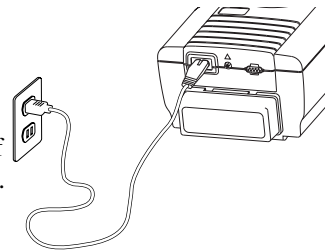

CAUTION!

Inspect the power cord often for any signs of damage. Replace a damaged cord immediately.

This device is activated when the power cord is connected. The Pressure On / Off button only turns the blower on/off.

First Time Setup

3. Place the REMstar Pro on a firm, flat surface.

CAUTION!

Make sure the REMstar Pro is away from any heating or cooling equipment (e.g. forced air vents, radiators, air conditioners). Also, make sure that bedding, curtains, or other items are not blocking the filter or vents of the REMstar Pro. Air must flow freely around the device for the system to work properly.

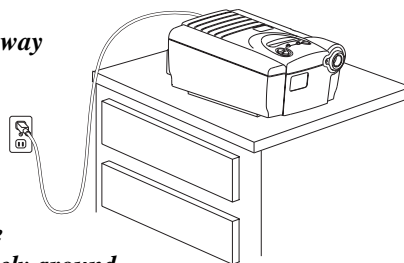

Device Settings

Once the power cord is plugged in, the REMstar Pro will perform a brief self-diagnostic test. The following message will then appear on the display screen.

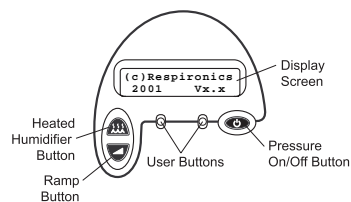

Display Screen: All device settings will appear here.

Pressure On/Off Button: Use this button to turn the air flow on or off. DO NOT turn the airflow on until the circuit tubing is connected.

Humidifier Button: Use this button when the optional REMstar Heated Humidifier has been prescribed. This button will control the optional heated humidifier's output. Follow the instructions included with the humidifier.

Ramp Button: Use this button to start the ramp cycle (which lowers the airflow pressure) or to enter the settings menu. This will allow you to fall asleep more easily.

User Buttons: These buttons can be used when entering various menus to change some of the device settings.

Device Settings

4. Follow the display screens to change the system settings. (The airflow must be turned OFF.)

IMPORTANT!

DO NOT use the REMstar Pro if the display is erratic. Contact your home care provider for further instructions.

a. The blower status will appear. Press the button below “Menu.”

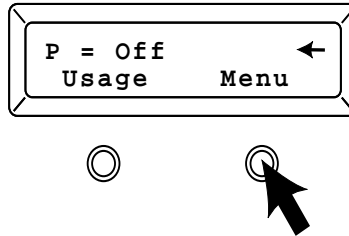

b. A message will display asking if you want to change the settings. Press the button below “Yes.”

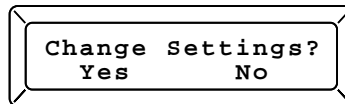

If you press “No,” go to page 14 for instructions.

NOTE: This menu can also be accessed (when the airflow is turned off) by pressing the ramp button. Pressing the ramp button (when the airflow is turned on) will lower the airflow pressure to the Minimum Ramp Pressure setting.

First Time Setup

The Ramp Feature

The Ramp feature will reduce the pressure and then gradually increase (ramp) the pressure to the prescription pressure setting so that you can fall asleep more comfortably. *If your physician prescribed ramp for you, the minimum ramp pressure setting will appear. If ramp has not been prescribed for you, go to Step d.*

Setting the Minimum Ramp Pressure

c. **The minimum ramp pressure will appear.** Your home care provider will have already set a minimum ramp pressure. If you feel the minimum ramp pressure is set too low or too high, you can change the setting. (Range: 4 cm H₂O - Prescription Pressure)

If the minimum ramp pressure is correct, press the button below “Yes.”

To change the pressure in 1 cm H₂O increments, press the button below “+1” until the desired pressure appears. Press the button below “Yes” to confirm the setting.

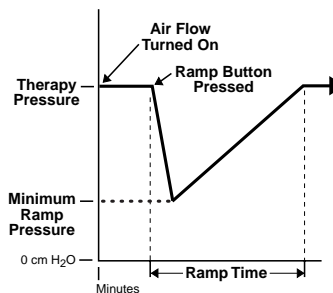
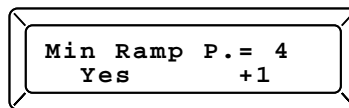

Turning the Alert Tone On or Off

- d. The audible mask alert is a beeping sound that the REMstar Pro makes when a large, continuous air leak has been detected in the circuit. You have the option of turning the alert tone On or Off.

If the setting is correct, press the button below “Yes.”

To change the setting, press the button below “No.”

Press the button below “Yes” to confirm the setting.

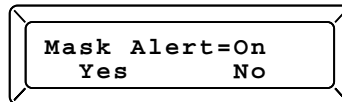

Setting Button Lights

- e. The button lights setting will appear. This setting allows you to have the lights behind the buttons turned on or off while the airflow is on. (The lights will always be on when the airflow is off.)

If the setting is correct, press the button below “Yes.”

To change the setting, press the button below “No.”

Press the button below “Yes” to confirm the setting.

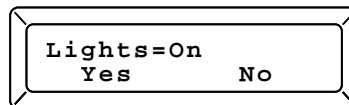

First Time Setup

FOSQ Test

When “Change Settings” appears, if you press the button below “No,” a screen will appear that says “FOSQ Test?”

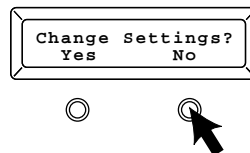

The FOSQ test is a “quality of life” questionnaire designed specifically for people with sleep disorders. The results allow health care professionals to see how therapy has improved the quality of your life. By completing the questionnaire periodically, you can provide valuable information about the effectiveness of your treatment. This device has the ability to record your answers on the SmartCard for later review by the health care provider. Contact your home care provider for further instructions.

IMPORTANT!

If your doctor or home care provider instructs you to complete the questionnaire, he will provide you with the instructions and the questions and you will enter your answers into the REMstar Pro. Make sure the SmartCard is installed before answering the questions.

A message will appear asking if you want to take the FOSQ test. If you want to take the test, Press the button below “Yes.”

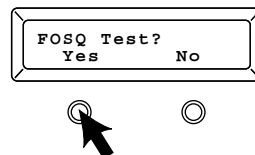

If you do not want to take the test, press the button below “No” and the display will go back to the main screen.

SmartCard

A SmartCard is installed in the side of the REMstar Pro to record information for the home care provider. Your home care provider may ask you to periodically remove the SmartCard and send it to him for evaluation.

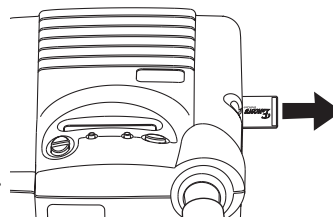

The arrow in the upper right corner of the display screen signifies that the SmartCard is installed properly.

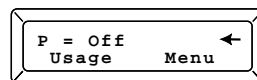

Assembling the Circuit

5. **Assemble the circuit.** You will need the following accessories in order to assemble the recommended circuit.
 - *Respironics Nasal Mask with integrated exhalation port*
(or *Respironics mask with separate exhalation port such as the Whisper Swivel®*)
 - *Respironics 6 ft. (1.83 m) Flexible Tubing*
 - *Respironics Headgear (for the mask; not shown)*

WARNING! *If the REMstar Pro is used for multiple persons (e.g., rental devices) a low-resistance, main flow bacteria filter should be installed in-line between the device and the circuit tubing. Pressures must be verified when alternate or optional accessories are in place.*

- a. **Connect the flexible tubing to the air outlet on the front of the REMstar Pro.**

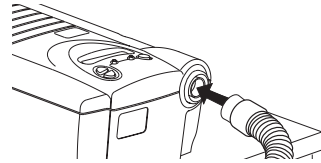

- b. **If you are using a mask with a built-in exhalation port:** Connect the mask's connector to the flexible tubing.

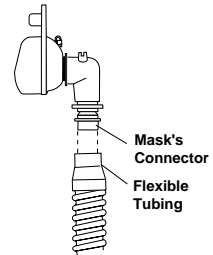

- If you are using a mask with a separate exhalation port:** Connect the exhalation port to the flexible tubing.

Position the exhalation port so that the vented air is blowing away from your face. Connect the mask's connector to the exhalation port.

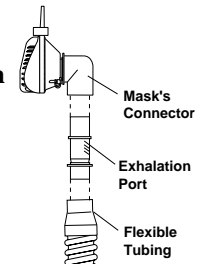

WARNING! *The exhalation port is designed to exhaust CO₂ from the circuit. Continuous flow is required for safe operation. Do not block or otherwise try to seal the air openings on the exhalation port.*

WARNING! *If you are using a full face mask (i.e., a mask covering both your mouth and your nose), the mask must be equipped with a safety (entrainment) valve.*

Accessories

Contact your home care provider for additional information on the optional accessories. When using optional accessories, always follow the instructions enclosed with the accessories.

Adding a Humidifier

The REMstar Heated Humidifier and REMstar Pass-over Humidifiers are available from your home care provider. The humidifiers may reduce nasal dryness and irritation by adding moisture (and heat if applicable) to the airflow.

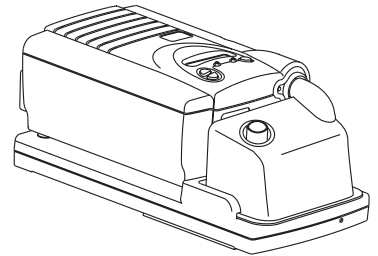

CAUTION!

For safe operation, the humidifier must always be positioned below the circuit connection at the mask and the air outlet on the REMstar Pro. The humidifier must be level for proper operation.

Adding Oxygen to the System

Oxygen may be added at the mask connection. Please note the warnings listed below when using oxygen with the REMstar Pro.

WARNING!

When using oxygen with the REMstar Pro, the oxygen supply must comply with the local regulations for medical oxygen.

WARNING!

When using oxygen with this system, a Respirationics Pressure Valve (Part number 302418) must be placed in-line with the patient circuit.

WARNING!

When using oxygen with this system, turn the REMstar Pro on before turning the oxygen on. Turn the oxygen off before turning the REMstar Pro off. This will prevent oxygen accumulation in the device.

WARNING!

Oxygen accelerates fires. Keep the REMstar Pro and the oxygen container away from heat, open flames, any oily substance, or other sources of ignition. DO NOT smoke in the area near the REMstar Pro or the oxygen.

Using a DC Power System

You can also use the REMstar Pro in a stationary recreational vehicle, boat or motor home with a 12 volt DC power source. Do not operate the REMstar Pro while the vehicle is in motion. Contact your home care provider for additional information.

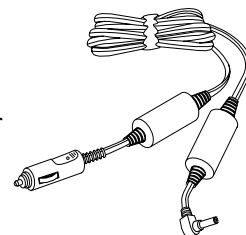

CAUTION!

Only use the Respironics DC power system available from your home care provider. Use of any other system may cause damage to the REMstar Pro or your vehicle.

CAUTION!

DC power is not intended to be used as battery back-up. DO NOT connect the DC power system while the REMstar Pro is operating on AC power. System damage may occur.

Using an Ultra-fine Filter

An optional ultra-fine filter can be used in addition to the pollen filter for more complete filtration of very fine particles. The ultra-fine filter is recommended for people who are sensitive to tobacco smoke or other small particles.

Carrying Case

The carrying case holds the REMstar Pro and accessories. When traveling by airplane, use the carrying case as carry-on luggage only. Never check the REMstar Pro through the baggage department.

Routine Use

Connecting the Circuit

IMPORTANT!

1. Connect the circuit.

Before each use, examine the flexible tubing for any damage or debris. Replace any damaged tubing.

- a. **Connect the mask to the headgear, following the instructions included with the headgear.**
- b. **If your home care provider has selected the Auto-On feature for you,** put on the mask and headgear, and breathe normally through your nose. The airflow should automatically turn ON when you begin breathing through the circuit. If the airflow does not turn on within four breaths, turn it ON by pressing the Pressure On/Off button on the top of the device. When operating the system with some mask types, some circuit configurations, or at higher altitudes, the airflow may NOT automatically turn on.

- or -

- b. **If your home care provider has not selected the Auto-On feature for you,** put on the mask and headgear, and immediately turn the airflow ON by pressing the Pressure On/Off button on the top of the device. Breathe normally through your nose.

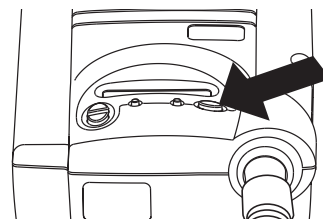

Adjusting the Circuit

2. **Adjust the circuit.** Lie down on your bed and adjust the flexible tubing so it is free to move if you turn in your sleep. Adjust the mask and headgear until you have a comfortable fit and there are no airflow leaks into your eyes.

When the airflow is on, the word “Menu” will no longer be displayed, and the pressure setting will now appear.

Starting Ramp

The Ramp feature will reduce the pressure and then gradually increase (ramp) the pressure to the therapeutic pressure setting so that you can fall asleep more comfortably. If your physician prescribed ramp for you, pressing the Ramp button will reduce the air pressure when you are trying to fall asleep. *Note: The ramp feature is not prescribed for all users.*

3. Press the Ramp button on the top of the device. You can use the Ramp button as often as you wish during the night. Refer to page 12 for additional details.

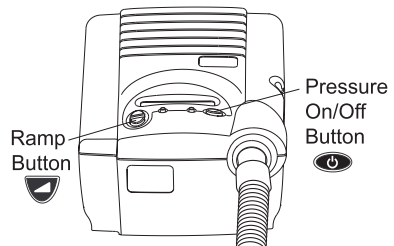

Turning the System OFF

4. Remove the mask and headgear. The airflow will automatically turn off (in approximately 30 seconds). If the audible mask alert is turned on, the alert tone will sound (in approximately 15 seconds after you remove the mask).

IMPORTANT!

The Auto-off feature may have been disabled by your home care provider. Press the Pressure On / Off button on the top of the REMstar Pro to turn the airflow OFF.

IMPORTANT!

The humidifier button is active only when a Respironics Heated Humidifier is connected or when the REMstar Pro is in the Setup Menu (refer to page 10).

Helpful Hints

- If the alert tone sounds, press any button on the REMstar Pro to silence the alert tone. Refer to the “Screen Messages” section of the manual for further instructions.
- Make sure that bedding, curtains, or other items are not blocking the filter or vents of the REMstar Pro. Air must flow freely around the device for the system to work properly.
- If the airflow from the REMstar Pro feels cold, move the circuit tubing so that it runs under your bed covers to reduce heat loss while you sleep.

Routine Use

Screen Displays

During use, any of the following messages may appear on the display screen.

1. “Mask Alert” - A large circuit leak, such as mask removal, has been detected.

What will happen:

- The alert tone will sound in approximately 15 seconds (if the mask alert feature has been turned on).
- The airflow will turn off in approximately 30 seconds (if the auto-off feature has been turned on).

What to do:

- Press any button on the REMstar Pro to silence the alert tone and clear the display screen.
- Check the circuit (flexible tubing, mask) for any leaks and adjust the mask and headgear.
- Press the Pressure On / Off button to restart the airflow.

IMPORTANT!

The audible mask alert setting can be turned on or off. See the “First Time Setup” section for instructions.

2. “Connect Pressure Line” - The flexible tubing has become disconnected or the REMstar Pro is not functioning correctly.

What will happen:

- The airflow will turn off and the alert tone will sound within 10 seconds.

What to do:

- Press any button on the REMstar Pro to silence the alert tone and clear the display screen.
- Reconnect the tubing.
- Press the Pressure On / Off button to restart the airflow.
- If the airflow does not start, contact your home care provider or Respironics for directions on having the REMstar Pro serviced. Please have the serial number of the device and the error code ready when you call.

IMPORTANT!

This alert setting cannot be turned on or off.

Screen Messages

3. “System Error ###” - The REMstar Pro is not functioning correctly and may need servicing.

What will happen:

- The airflow will turn off immediately.
- The alert tone will sound.
- The light behind the buttons will flash on and off.

What to do:

- Reset the REMstar Pro by unplugging the power cord from the electrical outlet and then plugging it in again.
- If the message appears again, contact your home care provider or Respironics for directions on having the device serviced. Please have the serial number of the device and the error code ready when you call.

IMPORTANT! *This alert setting cannot be turned on or off.*

4. “Remove Card” - The Encore SmartCard has been inserted improperly.

What to do:

- Remove the SmartCard. Reinsert the SmartCard making sure that the printed side of the card is facing up and the end with the arrow goes into the device first.
- If the message appears again, remove the card and contact your home care provider to have the SmartCard replaced. You can continue to use the REMstar Pro. Removing the SmartCard will not affect the performance of the REMstar Pro.
- If the SmartCard is not installed, the device usage will not be recorded. When a SmartCard is installed, an arrow will be displayed in the upper right corner of the screen.

5. “” - The SmartCard is in place.

6. “” = When the optional heated humidifier is connected, this indicates that the humidifier is on.

Traveling with the System

Packing the System

When you are traveling, use the carrying case for carry-on luggage only. The carrying case will not protect the system if it travels as checked baggage.

Security Stations

For convenience at security stations, there is a note on the bottom of the REMstar Pro stating that it is medical equipment. It may be helpful to bring this manual along with you when you travel to help security personnel understand the REMstar Pro.

Checking the Power Cord

If you are traveling to a country with a line voltage different than the one you are currently using, an international plug adapter may be required to make your power cord compatible with the power outlets of the country to which you are traveling. Contact your home care provider for additional information.

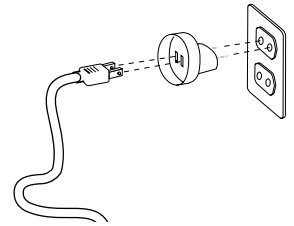

Cleaning the Filter

You should clean the filter at least once every two weeks under normal usage and replace it with a new one every six months.

CAUTION!

Operating the REMstar Pro with a dirty filter may keep the system from working properly and damage the REMstar Pro.

- 1. Remove the filter cap by gently pressing down on the two latches on top of the filter cap.**
- 2. Change the filter.**
 - a.** Remove the filter by gently pulling around the edges of the filter. Rinse the filter in a steady stream of running water. Squeeze out the water and repeat. Air dry the filter on a rack for 8 to 12 hours or in a clothes dryer for 15 to 20 minutes.
 - b.** Insert the filter into the filter area on the back of the REMstar Pro. Replace the filter cap.

CAUTION!

Never install a wet filter into the REMstar Pro. We recommend that you clean the filter in the morning and alternate using the two filters provided with the system to ensure sufficient drying time for the cleaned filter.

Routine Maintenance

Cleaning the System

Clean the mask and tubing daily.

WARNING!

To avoid electrical shock, unplug the REMstar Pro before cleaning. DO NOT immerse the REMstar Pro in any fluids.

- 1. Disconnect the flexible tubing from the REMstar Pro. Gently wash the tubing in a solution of warm water and mild detergent. Rinse the tubing thoroughly and air dry.**
- 2. Wipe the outside of the REMstar Pro with a cloth slightly dampened with water and mild detergent. Let the REMstar Pro dry before plugging in the power cord.**
- 3. Inspect the REMstar Pro, power cord, and all circuit parts for any damage after cleaning. Replace any damaged parts.**
- 4. For details on cleaning your mask and accessories, refer to the cleaning instructions packaged with the accessories.**

Reordering

Contact your home care provider to order accessories or replacement filters.

Service

The REMstar Pro does not require routine servicing.

CAUTION!

If you notice any unexplained changes in the performance of this device, if it is making unusual or harsh sounds, if it has been dropped or mishandled, if the enclosure is broken, or if water has entered the device, discontinue use. Contact your home care provider.

WARNING!

If the REMstar Pro malfunctions, contact your home care provider immediately. Never attempt to open the REMstar Pro's enclosure. Only Respirationics authorized service personnel may perform repairs and adjustments. Unauthorized service could cause injury, could invalidate the warranty, or could result in costly damage.

Routine Maintenance

Total Operation Time

To display the total operation time, press the button below “Usage.” The usage hours will display for 10 seconds and then return to the main screen.

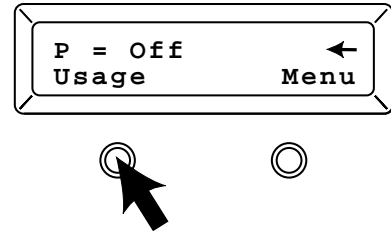

Total Operation Time Display

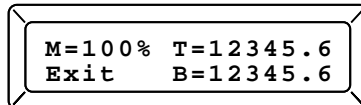

- M** = The amount of memory space available. The SmartCard records device usage information (e.g., a history of pressure settings; number of times the system was used for therapy). Some physicians and home care providers record this information. When “M=000%” appears, contact your home care provider if he/she has asked you to monitor the SmartCard’s memory level. If “M=---%” appears, the SmartCard is not installed.
- T** = The therapy hours are the total number of hours the device has operated with the airflow turned on. Like a trip meter in a car, the therapy hours can be reset to zero by the home care provider.
- B** = The total blower time is the total number of hours the device has been in use. This total includes factory testing time.
- Exit** = Returns the display to the main screen.

Troubleshooting

The table below lists troubleshooting solutions for common problems you may have with the REMstar Pro System. If none of the corrective actions solve the problem, contact your home care provider or Respironics.

Problem

Solutions

The “Mask Alert” message appears on the display screen and the alert tone is sounding.

Press any button on the REMstar Pro to silence the alert tone and clear the display screen. The system has detected a large leak in the circuit or you have taken the mask off without turning the airflow off. Check the circuit connections for leaks.

The “Connect Pressure Line” message appears on the display screen and the alert tone is sounding.

Press any button on the REMstar Pro to silence the alert tone and clear the display screen. The tubing has become disconnected from the system. Reconnect the tubing and press the Pressure On / Off button to restart the airflow. If the airflow does not restart, the REMstar Pro may not be operating correctly. Contact your home care provider or Respironics for directions on having the REMstar Pro serviced. Please have the serial number of the device ready when you call. Contact your home care provider for service.

Pressing the Ramp button does not reduce the air pressure.

Contact your home care provider. Your home care provider may not have prescribed ramp for you. Make sure the ramp pressure setting is lower than your CPAP pressure setting.

The airflow from the REMstar Pro seems warm.

Replace or clean the filter. Make sure the REMstar Pro is away from bedding or curtains that could block the flow of air around the device. Make sure the REMstar Pro is away from heating equipment (e.g., forced air vents, radiators).

The memory display reads “M=000%.”

The SmartCard records device usage information (e.g., a history of pressure settings, times the system was used for therapy). Some physicians and home care providers record this information to assist in your CPAP treatment. When “000%” is displayed, contact your home care provider if he/she has asked you to monitor the memory level. Information will still be recorded once “000%” is displayed.

Water is spilled onto or into the REMstar Pro.

Unplug the power cord from the AC wall outlet, pour out excess fluids and allow the device to dry out. Do not use the REMstar Pro until you contact your home care provider.

Troubleshooting

Problem

Solutions

The “Mask Alert” feature does not work.

The Mask Alert is a convenience feature that may not work at extreme altitudes or with some mask types or circuit configurations (i.e., full face mask). *This will not adversely affect the therapy you receive from the system.*

The REMstar Pro will not turn on.

Make sure the REMstar Pro is plugged into a working outlet. Contact your home care provider or Respironics.

The airflow will not automatically turn ON or OFF.

The Auto-on, Auto-off, and Mask Alert are convenience features that may not work with some mask types, circuit configurations, or at extreme altitudes. This will not adversely affect the therapy received from the system. The Auto-on and Auto-off settings may have been disabled by your home care provider.

The Mask Alert is not working.

In the settings menu, make sure the display reads “Mask Alert=On.” The Mask Alert is a convenience feature that may not work with some mask types, circuit configurations, or at extreme altitudes. This will not adversely affect the therapy received from the system.

The air pressure seems higher than usual.

The REMstar Pro may not be operating correctly. Contact your home care provider or Respironics for directions on having the device serviced. Please have the serial number ready when you call.

The memory display reads “M=---”

The SmartCard is not installed in the side of the REMstar Pro. Your home care provider or doctor may have decided that recording the device’s usage is not important for your therapy.

The “System Error” message appears on the display screen.

The REMstar Pro may not be operating correctly. Reset the device by unplugging the power cord from the electrical outlet and then plugging it in again. If the message appears again, contact your home care provider or Respironics for directions on having the REMstar Pro serviced. Please have the serial number ready when you call.

The “Remove Card” message appears on the display screen.

The Encore SmartCard has been inserted improperly. Remove the SmartCard. Reinsert the SmartCard making sure that the printed side of the card is facing up and the end with the arrow goes into the REMstar Pro first. If the message appears again, contact your home care provider or Respironics for directions on having the REMstar Pro serviced. Please have the serial number and the error code ready when you call.

Limited Warranty

Respironics, Inc.® warrants that this device shall be free from defects of workmanship and materials and will perform in accordance with the product specifications for a period of two (2) years from the date of sale by Respironics, Inc. to the dealer. If the product fails to perform in accordance with the product specifications, Respironics, Inc. will repair or replace, at its option, the defective material or part. Respironics, Inc. will pay customary freight charges from Respironics, Inc. to the dealer location only. This warranty does not cover damage caused by accident, misuse, abuse, alteration and other defects not related to material or workmanship.

RESPIRONICS, INC. DISCLAIMS ALL LIABILITY FOR ECONOMIC LOSS, LOSS OF PROFITS, OVERHEAD OR CONSEQUENTIAL DAMAGES WHICH MAY BE CLAIMED TO ARISE FROM ANY SALE OR USE OF THIS PRODUCT. SOME STATES DO NOT ALLOW THE EXCLUSION OR LIMITATION OF INCIDENTAL OR CONSEQUENTIAL DAMAGES, SO THE ABOVE LIMITATION OR EXCLUSION MAY NOT APPLY TO YOU.

THIS WARRANTY IS GIVEN IN LIEU OF ALL OTHER EXPRESS WARRANTIES. IN ADDITION, ANY IMPLIED WARRANTIES, INCLUDING ANY WARRANTY OF MERCHANTABILITY OR FITNESS FOR THE PARTICULAR PURPOSE ARE LIMITED TO TWO YEARS. SOME STATES DO NOT ALLOW LIMITATIONS ON HOW LONG AN IMPLIED WARRANTY LASTS, SO THE ABOVE LIMITATION MAY NOT APPLY TO YOU. THIS WARRANTY GIVES YOU SPECIFIC LEGAL RIGHTS, AND YOU MAY ALSO HAVE OTHER RIGHTS WHICH VARY FROM STATE TO STATE.

To exercise your rights under this warranty, contact your local, authorized Respironics, Inc. dealer or Respironics at 1001 Murry Ridge Lane, Murrysville, Pennsylvania 15668, 1-800-345-6443 (US and Canada only) or 1-724-387-4000.

IMPORTANT!

Fill in the information below when you receive this system.

Serial No.: _____ (Located on the bottom of the device)

System Prescribed for: _____

Date of Purchase or Rental: _____

Pressure Setting: _____ cm H₂O

Mask Type: _____

Mask Size: _____

If you have any questions concerning the system, contact:

• Home Care Company: _____

Telephone Number: _____

• Doctor: _____

Telephone Number: _____

• Respironics, Inc.

1001 Murry Ridge Lane

Murrysville, Pennsylvania

15668-8550 USA

Customer Service

Telephone Number: 1-800-345-6443 (US and Canada) or 1-724-387-4000